



FEDERATION INTERNATIONALE DES LUTTES ASSOCIEES
INTERNATIONAL FEDERATION OF ASSOCIATED WRESTLING STYLES



2nd Hungarian Grappling, Pankration & Combat Grappling Open 2010

- Budapest, 06-07 November 2010 -

RESULTS GRAPPLING – GI



photo by Tuzson Turjányi



Feuille de compétition / Competition Sheet

Hungarian Open - Grappling Schoolboys

STYLE : GI-M 55 kg

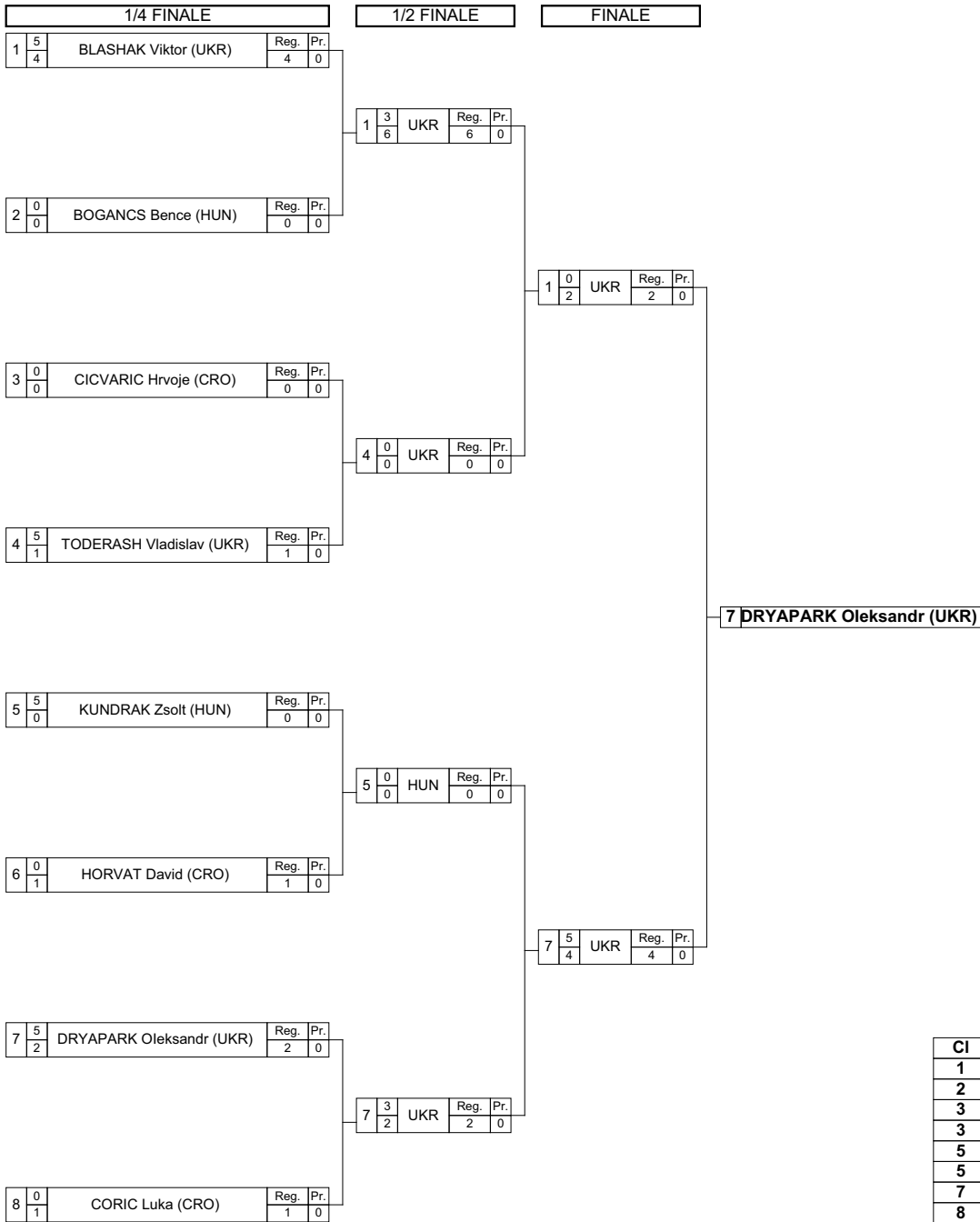

Classement

Cl	Pays	Nom
1	UKR	DRYAPARK Oleksandr
2	UKR	BLASHAK Viktor
3	UKR	TODERASH Vladislav
3	HUN	KUNDRAK Zsolt
5	HUN	BOGANCS Bence
5	CRO	CORIC Luka
7	CRO	HORVAT David
8	CRO	CICVARIC Hrvoje

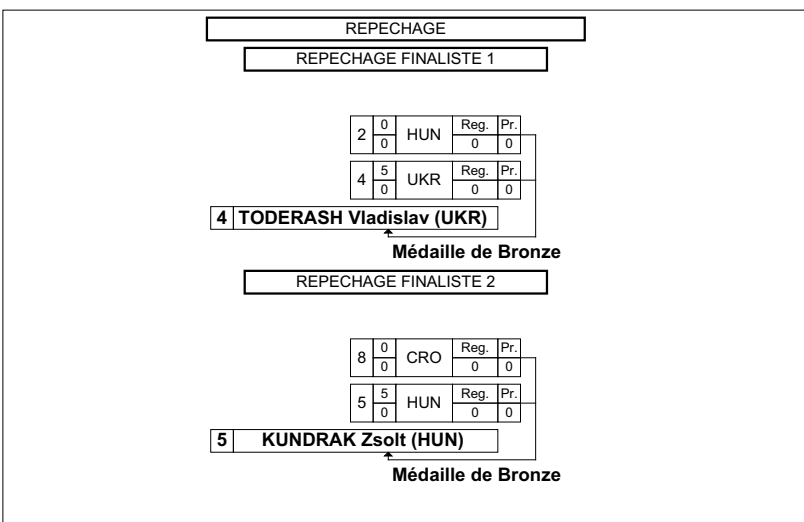

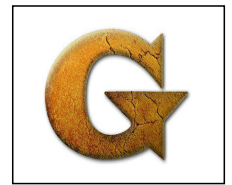

Feuille de compétition / Competition Sheet

Hungarian Open - Grappling Schoolboys

STYLE : GI-M -65 kg

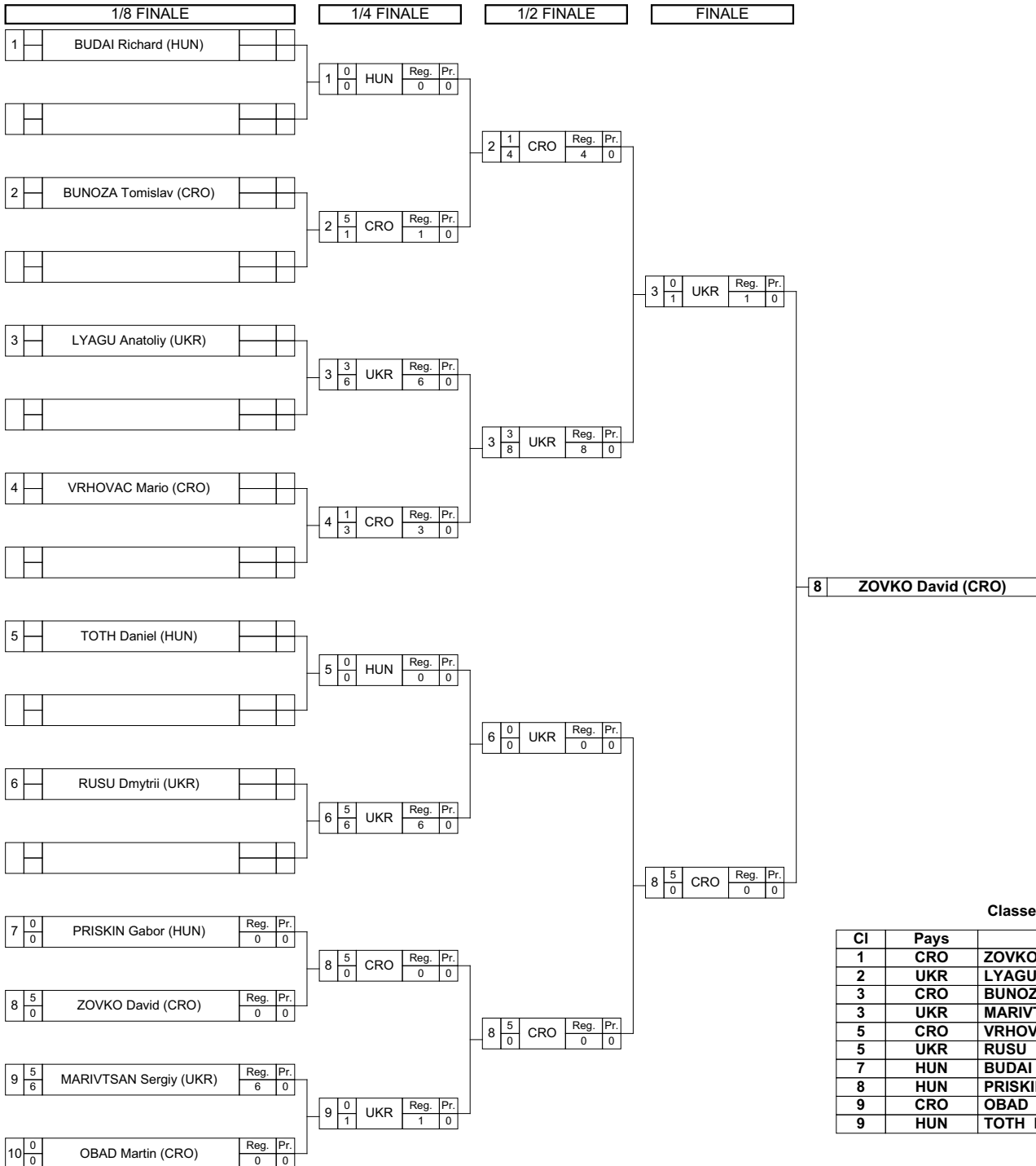

Classement

Cl	Pays	Nom
1	CRO	ZOVKO David
2	UKR	LYAGU Anatoliy
3	CRO	BUNOZA Tomislav
3	UKR	MARIVTSAN Sergiy
5	CRO	VRHOVAC Mario
5	UKR	RUSU Dmytrii
7	HUN	BUDAI Richard
8	HUN	PRISKIN Gabor
9	CRO	OBAD Martin
9	HUN	TOTH Daniel

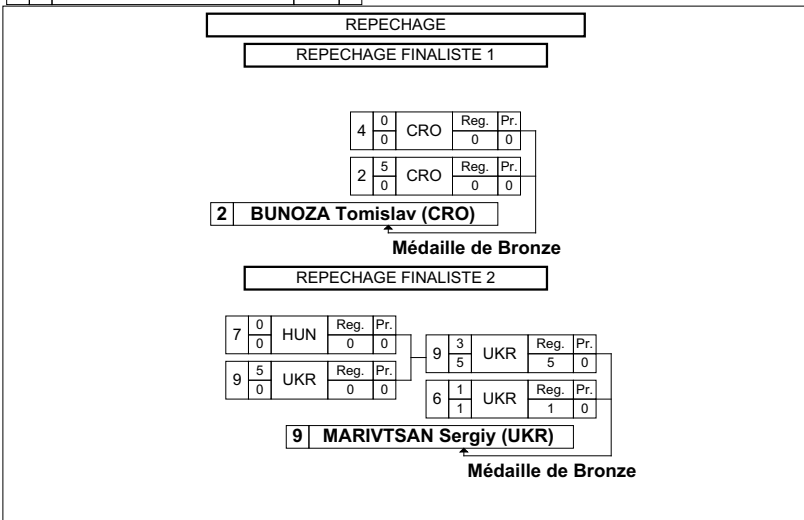

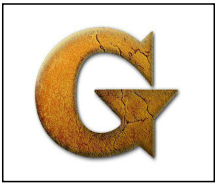

Feuille de compétition / Competition Sheet

Hungarian Open - Grappling Schoolboys

STYLE : GI-M +65 kg

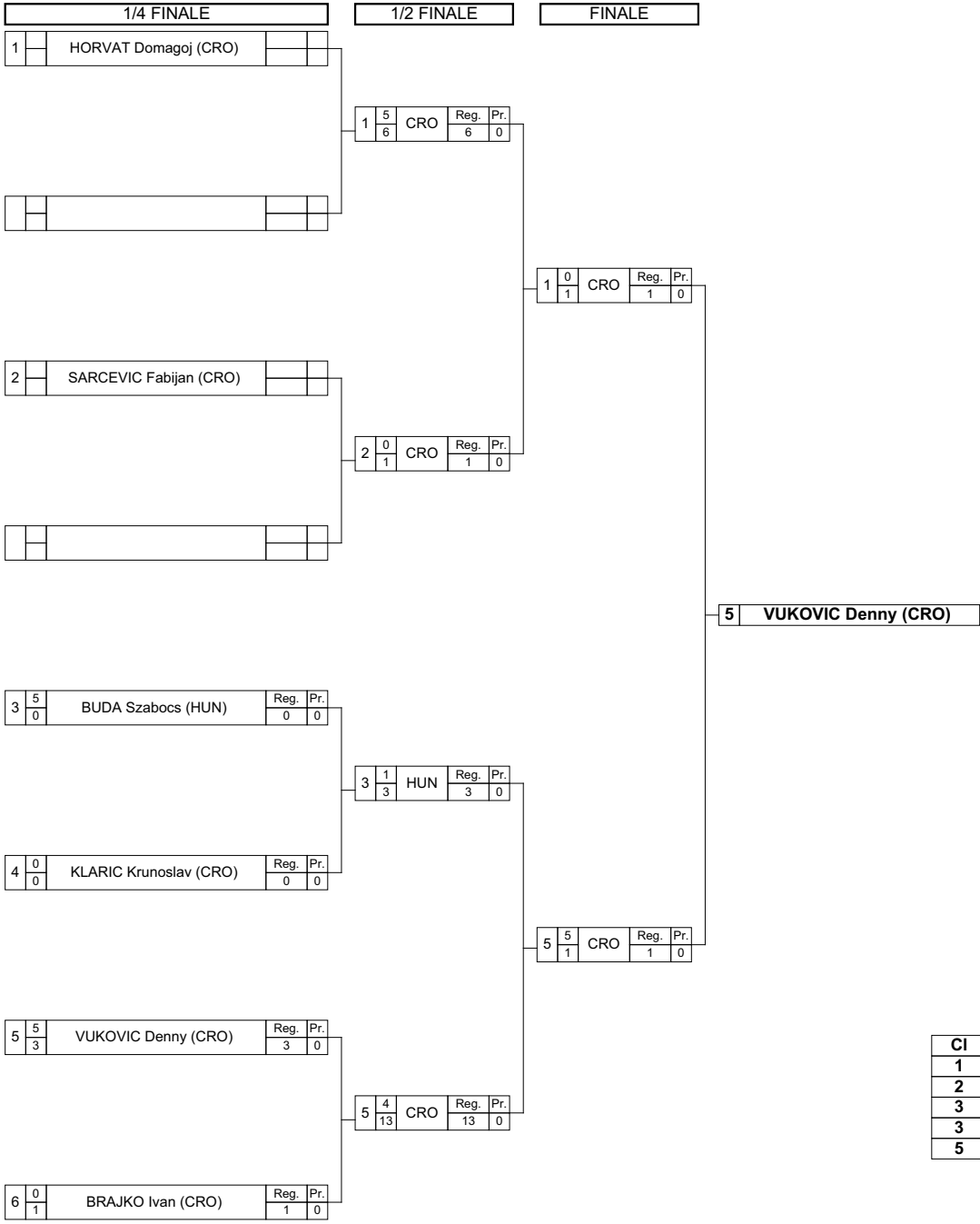

Classement

Cl	Pays	Nom
1	CRO	VUKOVIC Denny
2	CRO	HORVAT Domagoj
3	CRO	SARCEVIC Fabijan
3	CRO	BRAJKO Ivan
5		

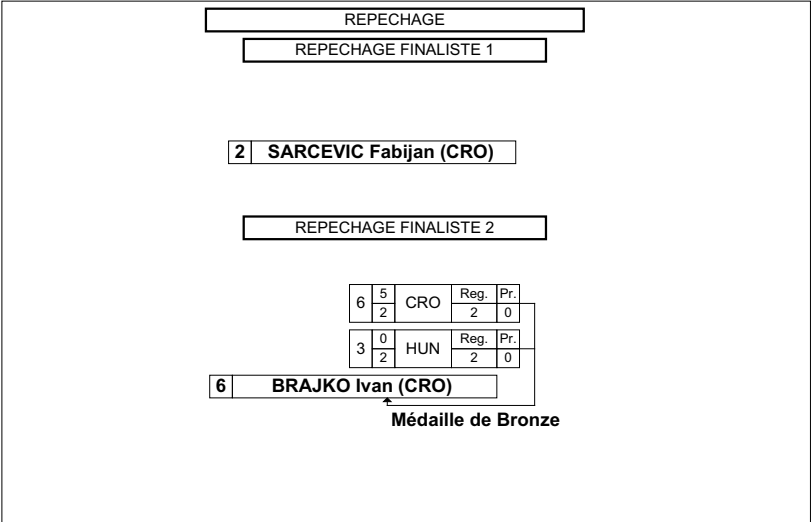



2010-11-06 - 2010-11-07 - BUDAPEST (HUN)

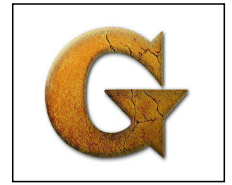

Feuille de compétition / Competition Sheet

Hungarian Open - Grappling Schoolboys

STYLE : GI-W 55 kg

TOUR : 1

1	0	KRASZ Kira (HUN)	Reg	Pr.	2	PETERFIA Eniko (HUN)
	0		0	0		
2	5	PETERFIA Eniko (HUN)	Reg	Pr.		
	4		4	0		

TOUR : 2

3	5	ISICHKO Valeria (UKR)	Reg	Pr.	3	ISICHKO Valeria (UKR)
	8		8	0		
1	0	KRASZ Kira (HUN)	Reg	Pr.		
	0		0	0		

TOUR : 3

2	0	PETERFIA Eniko (HUN)	Reg	Pr.	3	ISICHKO Valeria (UKR)
	1		1	0		
3	5	ISICHKO Valeria (UKR)	Reg	Pr.		
	4		4	0		

Classement

Cl	Pays	Nom	Points
1	UKR	ISICHKO Valeria	10
2	HUN	PETERFIA Eniko	5
3	HUN	KRASZ Kira	0



2010-11-06 - 2010-11-07 - BUDAPEST (HUN)

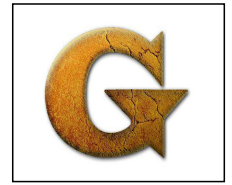

Feuille de compétition / Competition Sheet

Hungarian Open - Grappling Schoolboys

STYLE : GI-W +55 kg

TOUR : 1

1	5	MIHALJ Iva (CRO)	Reg	Pr.	1	MIHALJ Iva (CRO)
	5		5	0		
2	0	SABO Mirna (CRO)	Reg	Pr.		
	0		0	0		

TOUR : 2

3	0	HABADA Anita (CRO)	Reg	Pr.	1	MIHALJ Iva (CRO)
	0		0	0		
1	5	MIHALJ Iva (CRO)	Reg	Pr.		
	6		6	0		

TOUR : 3

2	4	SABO Mirna (CRO)	Reg	Pr.	2	SABO Mirna (CRO)
	12		12	0		
3	1	HABADA Anita (CRO)	Reg	Pr.		
	1		1	0		

Classement

Cl	Pays	Nom	Points
1	CRO	MIHALJ Iva	10
2	CRO	SABO Mirna	4
3	CRO	HABADA Anita	1

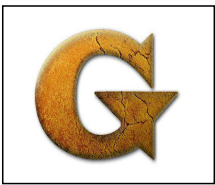

STYLE : GI-M 65 kg



Classement

Cl	Pays	Nom
1	HUN	LAKATOS Sandor
2	HUN	BOGANCS Gergo
3	HUN	NAGY Andras
3	RUS	CHISTYAKOV Nikita
6	CRO	RAMCIC Stjepan
6	CRO	KLEPO Ante

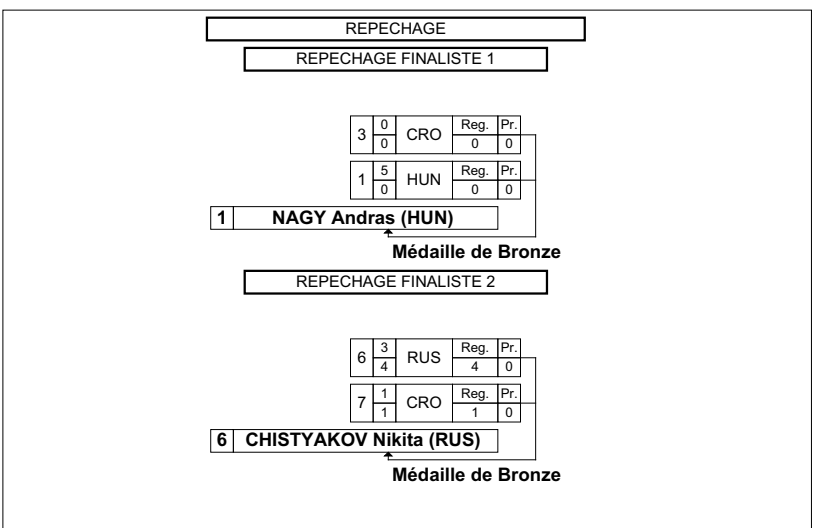



2010-11-06 - 2010-11-07 - BUDAPEST (HUN)

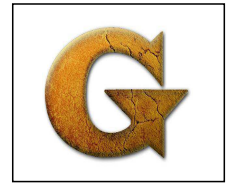

Feuille de compétition / Competition Sheet

Hungarian Open - Grappling Cadets

STYLE : GI-M +75 kg

TOUR : 1

1	5 0	ISICHKO Yaroslav (UKR)	Reg 0	Pr. 0	1	ISICHKO Yaroslav (UKR)
2	0 0	SYYKEL Victor (UKR)	Reg 0	Pr. 0		

Classement

Cl	Pays	Nom	Points
1	UKR	ISICHKO Yaroslav	5
2	UKR	SYYKEL Victor	0



2010-11-06 - 2010-11-07 - BUDAPEST (HUN)

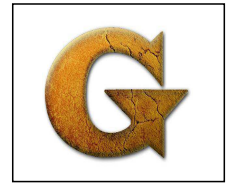

Feuille de compétition / Competition Sheet

Hungarian Open - Grappling Juniors

STYLE : GI-M 70 kg

TOUR : 1

1	0	DORIC Robert (CRO)	Reg	Pr.	2	SAJTOS Laszlo (HUN)
	0		0	0		
2	5	SAJTOS Laszlo (HUN)	Reg	Pr.		
	0		0	0		

Classement

Cl	Pays	Nom	Points
1	HUN	SAJTOS Laszlo	5
2	CRO	DORIC Robert	0



STYLE : GI-M 70 kg

TOUR : 1

1	5 1	DEBRECZENI David (HUN)	Reg 1	Pr. 0	1	DEBRECZENI David (HUN)
2	0 0	LAZAR Szabolcs (HUN)	Reg 0	Pr. 0		
3	0 0	DARBYSON-BILLINGHAM J. (CAN)	Reg 0	Pr. 0	4	KUNDRAK Attila (HUN)
4	5 0	KUNDRAK Attila (HUN)	Reg 0	Pr. 0		

TOUR : 2

5	0 0	DI LIBERTI Alessio (ITA)	Reg 0	Pr. 0	1	DEBRECZENI David (HUN)
1	5 0	DEBRECZENI David (HUN)	Reg 0	Pr. 0		
2	0 1	LAZAR Szabolcs (HUN)	Reg 1	Pr. 0	3	DARBYSON-BILLINGHAM J. (CAN)
3	5 6	DARBYSON-BILLINGHAM J. (CAN)	Reg 6	Pr. 0		

TOUR : 3

4	5 4	KUNDRAK Attila (HUN)	Reg 4	Pr. 0	4	KUNDRAK Attila (HUN)
1	0 0	DEBRECZENI David (HUN)	Reg 0	Pr. 0		
5	0 0	DI LIBERTI Alessio (ITA)	Reg 0	Pr. 0	2	LAZAR Szabolcs (HUN)
2	5 0	LAZAR Szabolcs (HUN)	Reg 0	Pr. 0		

TOUR : 4

3	5 6	DARBYSON-BILLINGHAM J. (CAN)	Reg 6	Pr. 0	3	DARBYSON-BILLINGHAM J. (CAN)
1	0 0	DEBRECZENI David (HUN)	Reg 0	Pr. 0		
4	5 0	KUNDRAK Attila (HUN)	Reg 0	Pr. 0	4	KUNDRAK Attila (HUN)
5	0 0	DI LIBERTI Alessio (ITA)	Reg 0	Pr. 0		

TOUR : 5

2	0 0	LAZAR Szabolcs (HUN)	Reg 0	Pr. 0	4	KUNDRAK Attila (HUN)
4	5 0	KUNDRAK Attila (HUN)	Reg 0	Pr. 0		
3	5 0	DARBYSON-BILLINGHAM J. (CAN)	Reg 0	Pr. 0	3	DARBYSON-BILLINGHAM J. (CAN)
5	0 0	DI LIBERTI Alessio (ITA)	Reg 0	Pr. 0		

Classement

Cl	Pays	Nom	Points
1	HUN	KUNDRAK Attila	20
2	CAN	DARBYSON-BILLINGHAM J.	15
3	HUN	DEBRECZENI David	10
4	HUN	LAZAR Szabolcs	5
5	ITA	DI LIBERTI Alessio	0

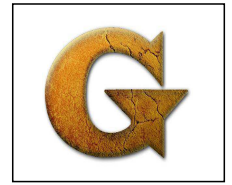

Feuille de compétition / Competition Sheet

Hungarian Open - Grappling Seniors

STYLE : GI-M 75 kg

TOUR : 1

1	0	GATI Nandor (HUN)	Reg	Pr.	2	TABORI Kristof (HUN)
	0		0	0		
2	5	TABORI Kristof (HUN)	Reg	Pr.	4	TOTH Zoltan (HUN)
	0		0	0		
3	1	TOTH Mate (HUN)	Reg	Pr.	3	TOTH Mate (HUN)
	3		3	0		
4	3	TOTH Zoltan (HUN)	Reg	Pr.	4	TOTH Zoltan (HUN)
	9		9	0		

TOUR : 2

1	0	GATI Nandor (HUN)	Reg	Pr.	3	TOTH Mate (HUN)
	0		0	0		
3	3	TOTH Mate (HUN)	Reg	Pr.	4	TOTH Zoltan (HUN)
	2		2	0		
2	1	TABORI Kristof (HUN)	Reg	Pr.	4	TOTH Zoltan (HUN)
	1		1	0		
4	3	TOTH Zoltan (HUN)	Reg	Pr.	4	TOTH Zoltan (HUN)
	2		2	0		

TOUR : 3

1	0	GATI Nandor (HUN)	Reg	Pr.	4	TOTH Zoltan (HUN)
	1		1	0		
4	5	TOTH Zoltan (HUN)	Reg	Pr.	2	TABORI Kristof (HUN)
	3		3	0		
2	5	TABORI Kristof (HUN)	Reg	Pr.	2	TABORI Kristof (HUN)
	2		2	0		
3	0	TOTH Mate (HUN)	Reg	Pr.	2	TABORI Kristof (HUN)
	1		1	0		

Classement

Cl	Pays	Nom	Points
1	HUN	TOTH Zoltan	11
2	HUN	TABORI Kristof	11
3	HUN	TOTH Mate	4
4	HUN	GATI Nandor	0

**STYLE : GI-M 80 kg****TOUR : 1**

1	5 3	EVANS Jaret (CAN)	Reg 3	Pr. 0	1	EVANS Jaret (CAN)
2	0 0	FEKETE Csaba (HUN)	Reg 0	Pr. 0		
3	0 0	SREBNICKI Lukasz (POL)	Reg 0	Pr. 0	4	KTORIDES Aristides (HUN)
4	3 11	KTORIDES Aristides (HUN)	Reg 11	Pr. 0		

TOUR : 2

5	0 0	DOMBROVSKYI O. (UKR)	Reg 0	Pr. 0	1	EVANS Jaret (CAN)
1	5 3	EVANS Jaret (CAN)	Reg 3	Pr. 0		
2	0 0	FEKETE Csaba (HUN)	Reg 0	Pr. 0	3	SREBNICKI Lukasz (POL)
3	5 0	SREBNICKI Lukasz (POL)	Reg 0	Pr. 0		

TOUR : 3

4	0 0	KTORIDES Aristides (HUN)	Reg 0	Pr. 0	1	EVANS Jaret (CAN)
1	5 3	EVANS Jaret (CAN)	Reg 3	Pr. 0		
5	1 1	DOMBROVSKYI O. (UKR)	Reg 1	Pr. 0	2	FEKETE Csaba (HUN)
2	3 5	FEKETE Csaba (HUN)	Reg 5	Pr. 0		

TOUR : 4

3	0 0	SREBNICKI Lukasz (POL)	Reg 0	Pr. 0	1	EVANS Jaret (CAN)
1	5 3	EVANS Jaret (CAN)	Reg 3	Pr. 0		
4	0 0	KTORIDES Aristides (HUN)	Reg 0	Pr. 0	5	DOMBROVSKYI O. (UKR)
5	5 0	DOMBROVSKYI O. (UKR)	Reg 0	Pr. 0		

TOUR : 5

2	5 0	FEKETE Csaba (HUN)	Reg 0	Pr. 0	2	FEKETE Csaba (HUN)
4	0 0	KTORIDES Aristides (HUN)	Reg 0	Pr. 0		
3	5 0	SREBNICKI Lukasz (POL)	Reg 0	Pr. 0	3	SREBNICKI Lukasz (POL)
5	0 1	DOMBROVSKYI O. (UKR)	Reg 1	Pr. 0		

Classement

Cl	Pays	Nom	Points
1	CAN	EVANS Jaret	20
2	POL	SREBNICKI Lukasz	10
3	HUN	FEKETE Csaba	8
4	UKR	DOMBROVSKYI O.	6
5	HUN	KTORIDES Aristides	3

**STYLE : GI-M 90 kg****TOUR : 1**

1	0	ADAM Gabor (HUN)	Reg	Pr.	2	HAVAS Balazs (HUN)
	0		0	0		
2	5	HAVAS Balazs (HUN)	Reg	Pr.		
	4		4	0		
3	0	TOKAR Adam (HUN)	Reg	Pr.	4	SZCZECH Sebastian (POL)
	0		0	0		
4	5	SZCZECH Sebastian (POL)	Reg	Pr.		
	1		1	0		

TOUR : 2

1	1	ADAM Gabor (HUN)	Reg	Pr.	3	TOKAR Adam (HUN)
	2		2	0		
3	3	TOKAR Adam (HUN)	Reg	Pr.		
	4		4	0		
2	3	HAVAS Balazs (HUN)	Reg	Pr.	2	HAVAS Balazs (HUN)
	6		6	0		
4	0	SZCZECH Sebastian (POL)	Reg	Pr.		
	0		0	0		

TOUR : 3

1	0	ADAM Gabor (HUN)	Reg	Pr.	4	SZCZECH Sebastian (POL)
	0		0	0		
4	5	SZCZECH Sebastian (POL)	Reg	Pr.		
	0		0	0		
2	5	HAVAS Balazs (HUN)	Reg	Pr.	2	HAVAS Balazs (HUN)
	3		3	0		
3	0	TOKAR Adam (HUN)	Reg	Pr.		
	1		1	0		

Classement

Cl	Pays	Nom	Points
1	HUN	HAVAS Balazs	13
2	POL	SZCZECH Sebastian	10
3	HUN	TOKAR Adam	3
4	HUN	ADAM Gabor	1



2010-11-06 - 2010-11-07 - BUDAPEST (HUN)

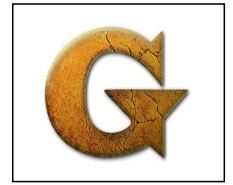

Feuille de compétition / Competition Sheet

Hungarian Open - Grappling Seniors

STYLE : GI-M Abs kg

TOUR : 1

1	0	MOLNAR Karoly (HUN)	Reg	Pr.	2	MORVAI Laszlo (HUN)
	0		0	0		
2	5	MORVAI Laszlo (HUN)	Reg	Pr.		
	0		0	0		

TOUR : 2

3	5	SREBNICKI Lukasz (POL)	Reg	Pr.	3	SREBNICKI Lukasz (POL)
	4		4	0		
1	0	MOLNAR Karoly (HUN)	Reg	Pr.		
	0		0	0		

TOUR : 3

2	5	MORVAI Laszlo (HUN)	Reg	Pr.	2	MORVAI Laszlo (HUN)
	3		3	0		
3	0	SREBNICKI Lukasz (POL)	Reg	Pr.		
	0		0	0		

Classement

Cl	Pays	Nom	Points
1	HUN	MORVAI Laszlo	10
2	POL	SREBNICKI Lukasz	5
3	HUN	MOLNAR Karoly	0



FEDERATION INTERNATIONALE DES LUTTES ASSOCIEES
INTERNATIONAL FEDERATION OF ASSOCIATED WRESTLING STYLES

2° HUNGARIAN OPEN

Budapest (HUN) – 06-07 November 2010

Grappling Gi – Schoolgirls 45kg

1. Adriana Vukovic (CRO)

Grappling Gi – Women Cadets 55kg

1. Eszter Pozsarko (HUN)

Grappling Gi – Men Juniors 80kg

1. Legawiec Bruno (POL)

Grappling Gi – Women Juniors 70kg

1. Kitti Heiter (HUN)

Grappling Gi – Women Seniors 50kg

1. Ganna Isichko (UKR)