

# SENIOR EUROPEAN CHAMPIONSHIP



**FILA**

[WWW.FILA-WRESTLING.COM](http://WWW.FILA-WRESTLING.COM)

**BRUSSELS (BEL) 27-30 JUNE 2012**

**RESULTS – NO-GI GRAPPLING**



**B.A.W.S**



# Feuille de compétition / Competition Sheet

## European Championship - Grappling



STYLE : NoGi-M 62 kg



### Classement

Cl	Pays	Nom
1	SWE	ALBAZI Amir
2	FRA	PETSHI Kevin
3	POL	ROSA Krzysztof
3	NED	PEUTE Jordi
5	CRO	CENAN Domagoj
5	ESP	RONQUILLO Alfredo J
7	UKR	BARANOV Dmytro
8	GER	AITA Samir
9	RUS	ZALEEV Georgy
10	ITA	CAZZOLA Matteo

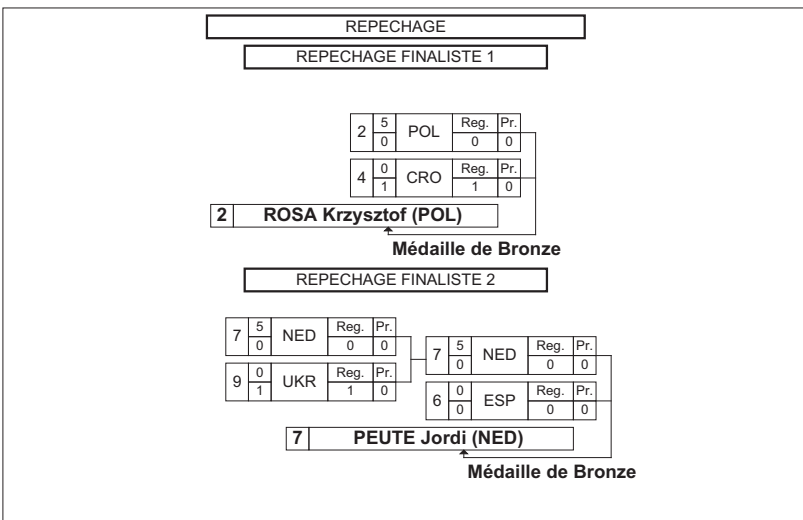



# Feuille de compétition / Competition Sheet

## European Championship - Grappling



STYLE : NoGi-M 66 kg

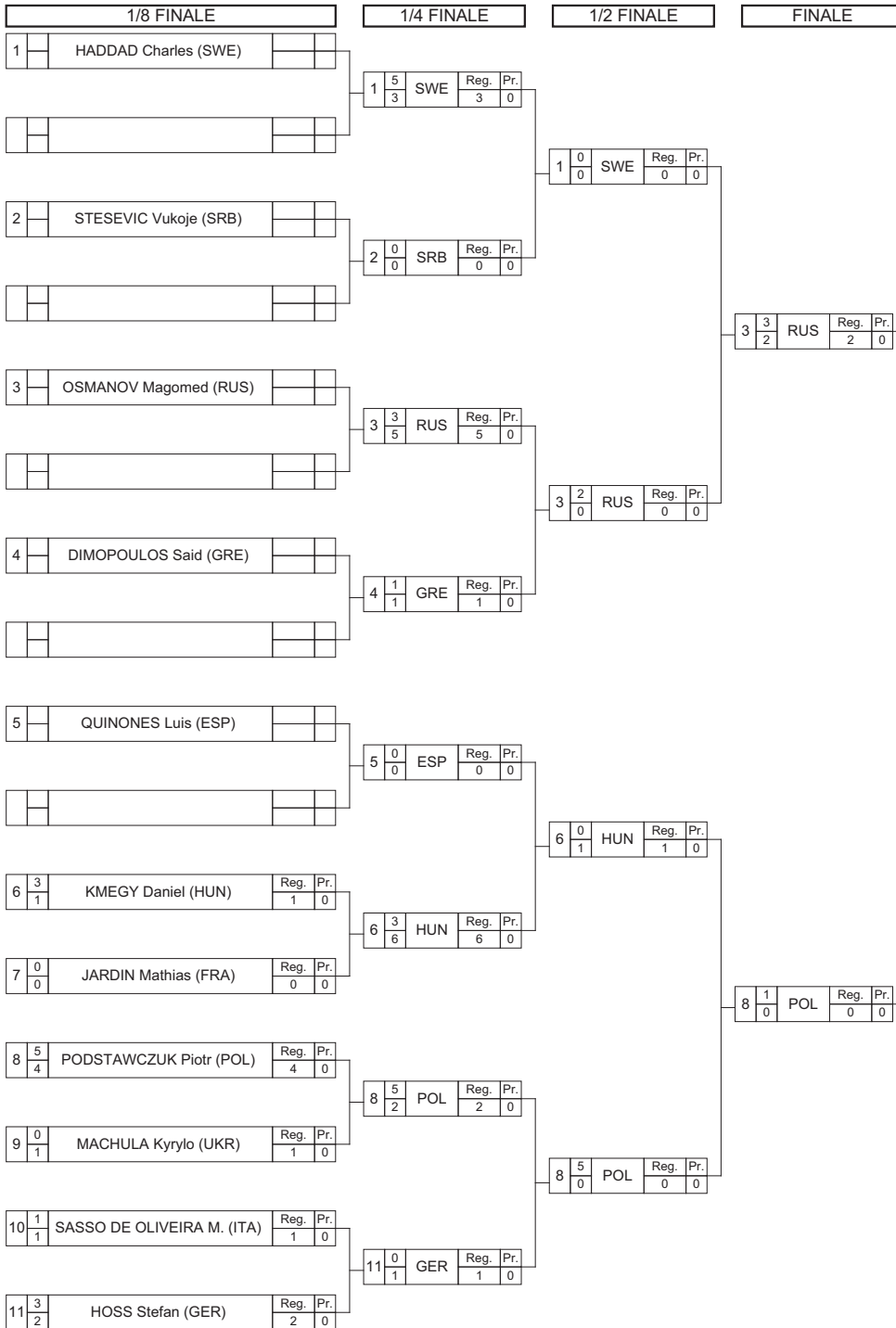

3 OSMANOV Magomed (RUS)

### Classement

Cl	Pays	Nom
1	RUS	OSMANOV Magomed
2	POL	PODSTAWCZUK Piotr
3	GRE	DIMOPOULOS Said
3	HUN	KMEGY Daniel
5	SWE	HADDAD Charles
5	GER	HOSS Stefan
7	ITA	SASSO DE OLIVEIRA M.
8	UKR	MACHULA Kyrylo
9	FRA	JARDIN Mathias
10	SRB	STESEVIC Vukoje
11	ESP	QUINONES Luis

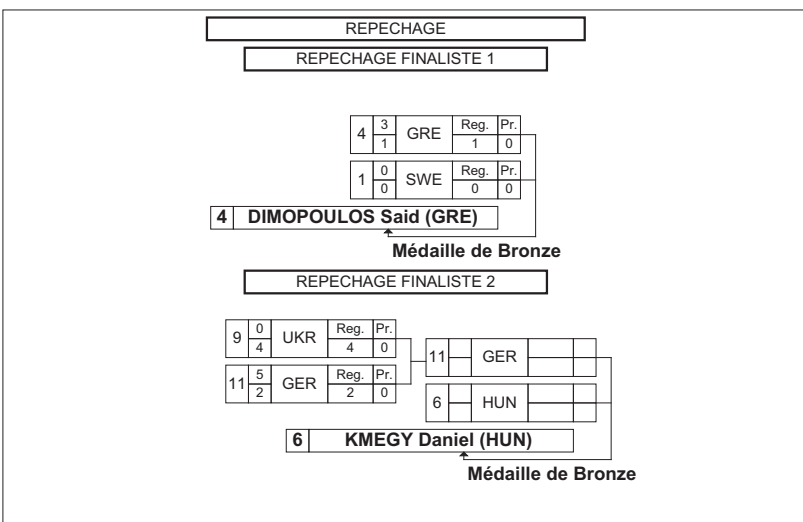



# Feuille de compétition / Competition Sheet

## European Championship - Grappling



STYLE : NoGi-M 71 kg



### Classement

Cl	Pays	Nom
1	POL	POLOK Maciej
2	FRA	LANDU Yves
3	SRB	MILICEVIC A.
3	CRO	MARIJANOVIC Petar
5	ESP	ALCALDE Francisco
5	GER	TENHUENFELD Gerhard
7	GRE	PASCHALDIS Georgios
8	ITA	ZARROLI Remo
9	BEL	DEMOULIN Rudy
10	RUS	UTKIN Igor
11	LUX	TEIXEIRA Jose

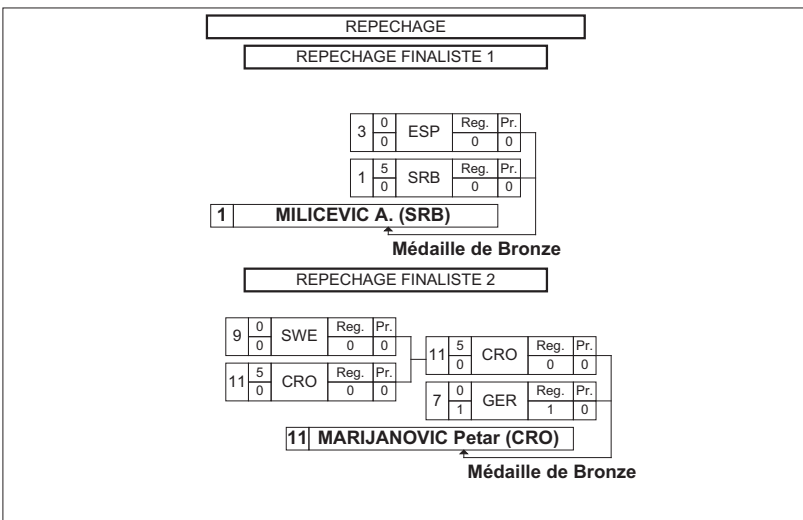



# Feuille de compétition / Competition Sheet

## European Championship - Grappling



STYLE : NoGi-M 77 kg

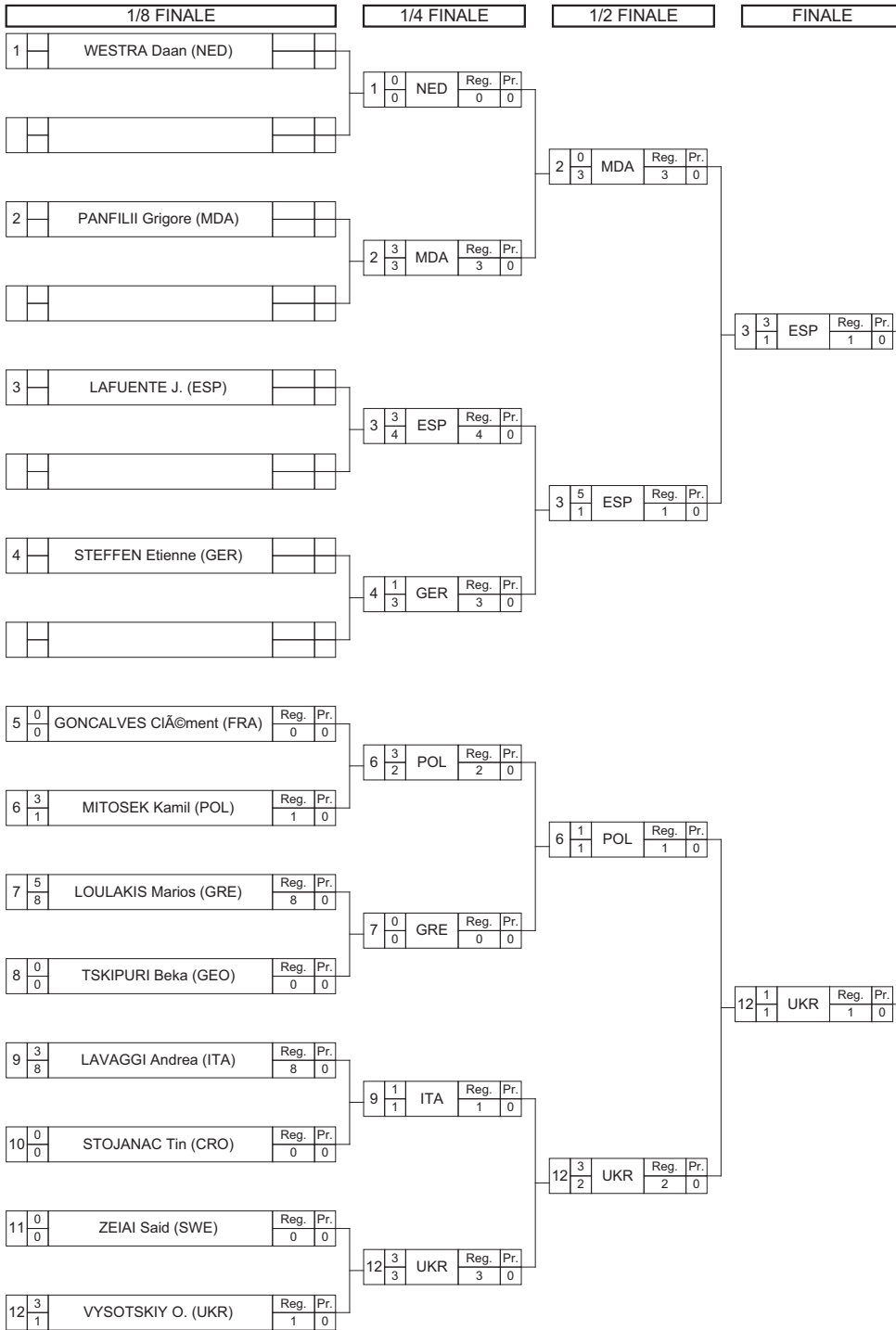

3 LAFUENTE J. (ESP)

### Classement

Cl	Pays	Nom
1	ESP	LAFUENTE J.
2	UKR	VYSOTSKIY Oleksandr
3	MDA	PANFILII Grigore
3	POL	MITOSEK Kamil
5	GER	STEFFEN Etienne
5	SWE	ZEIAI Said
7	GRE	LOULAKIS Marios
8	ITA	LAVAGGI Andrea
9	FRA	GONCALVES Clément
10	NED	WESTRA Daan
11	GEO	TSKIPURI Beka
11	CRO	STOJANAC Tin

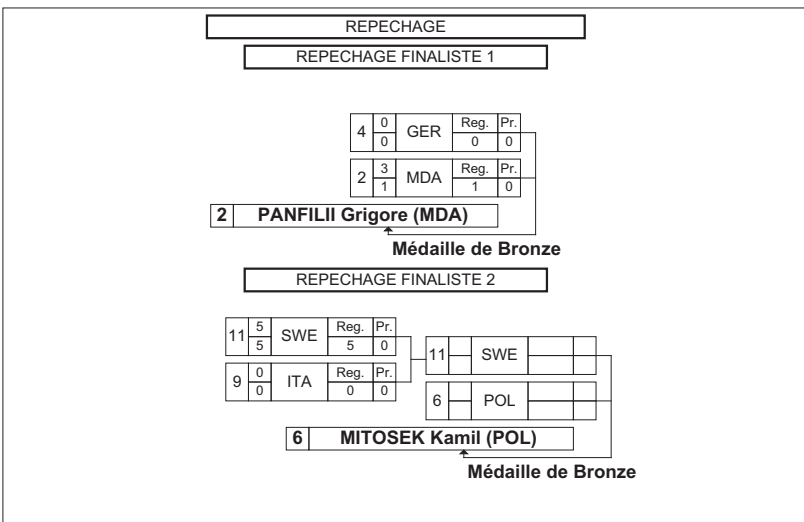



# Feuille de compétition / Competition Sheet

## European Championship - Grappling



STYLE : NoGi-M 84 kg



### Classement

Cl	Pays	Nom
1	POL	GLABUS Maciej
2	SRB	OBRADOVIC Milos
3	RUS	GUGOV Islam
3	ITA	ANACORETA Luca
5	BEL	CHAABI Said
5	SWE	LAVIN Martin
7	ESP	SANTANA C.
8	GER	LOKHOV Sergej
9	FRA	HUGOT Jerome
10	UKR	RYNDOVSKYI Maksim
11	CRO	ERKAPIC Miro

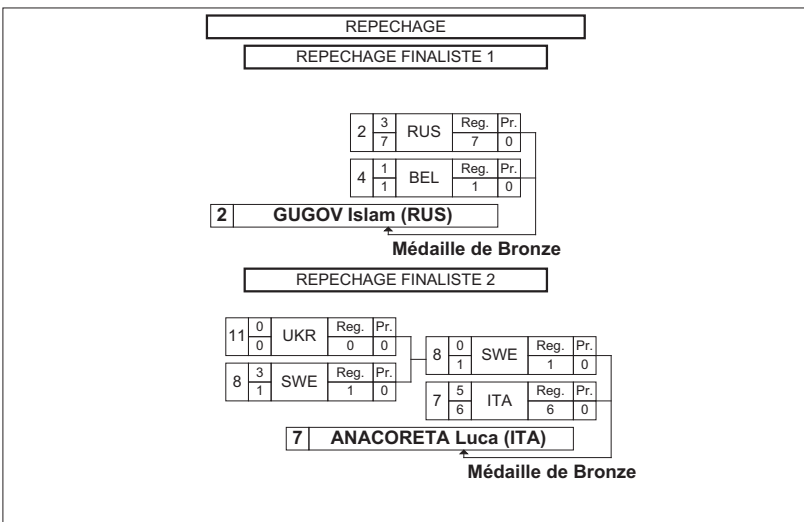



# Feuille de compétition / Competition Sheet

## European Championship - Grappling



STYLE : NoGi-M 92 kg

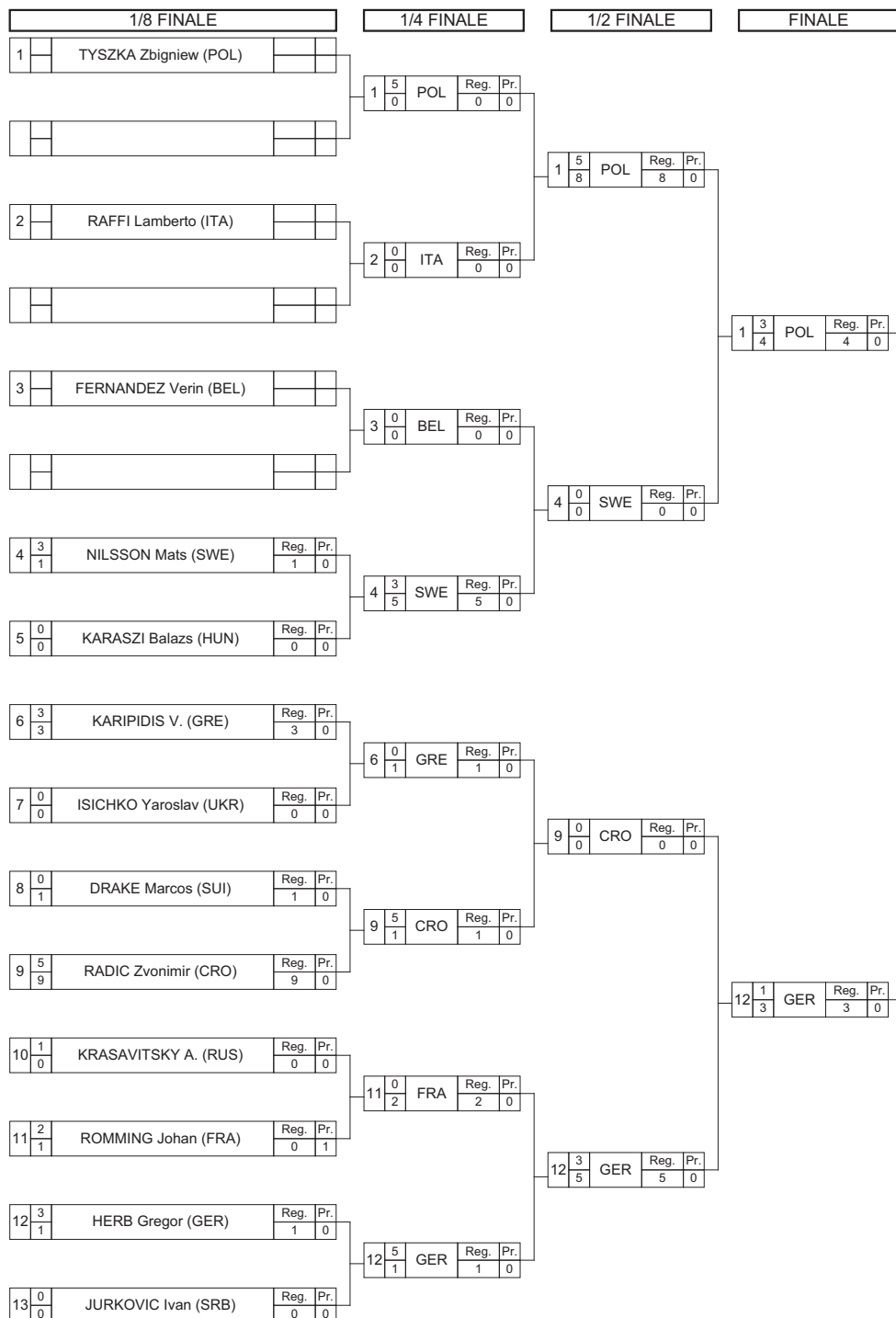

1 TYSZKA Zbigniew (POL)

### Classement

Cl	Pays	Nom
1	POL	TYSZKA Zbigniew
2	GER	HERB Gregor
3	SWE	NILSSON Mats
3	FRA	ROMMING Johan
5	ITA	RAFFI Lamberto
5	CRO	RADIC Zvonimir
7	GRE	KARIPIDIS V.
8	SRB	JURKOVIC Ivan
9	RUS	KRASAVITSKY A.
10	SUI	DRAKE Marcos
11	HUN	KARASZI Balazs
12	UKR	ISICHKO Yaroslav
13	BEL	FERNANDEZ Verin

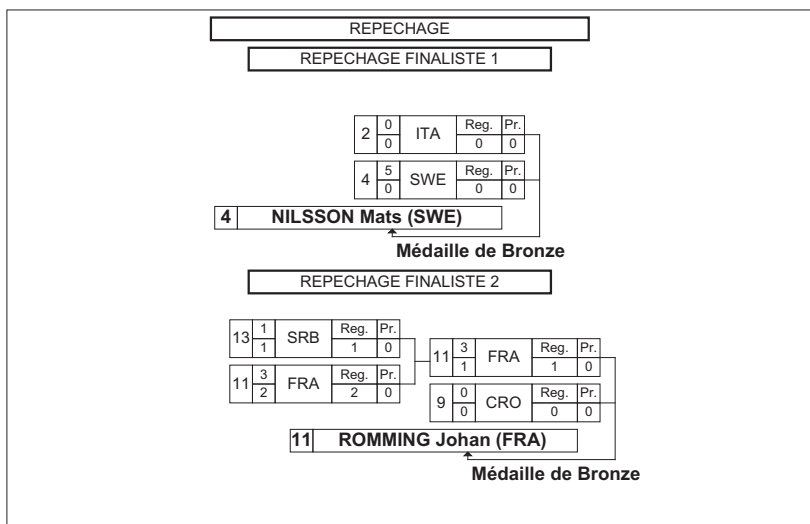







# Feuille de compétition / Competition Sheet

## European Championship - Grappling



STYLE : NoGi-M p100 kg



### Classement

Cl	Pays	Nom
1	ESP	ESPINO Juan
2	HUN	KALMAR Istvan
3	GER	MASUCH Manuel
3	POL	AGAPOW Krzysztof
5	SWE	STRANDNER Magnus
5	CRO	PILIPOVIC Vlado
7	ITA	FREZZA Alessandro
8	SRB	SANTRAC Nenad
9	GEO	TKEMALADZE Grigor
10	RUS	BOGDANOV Victor

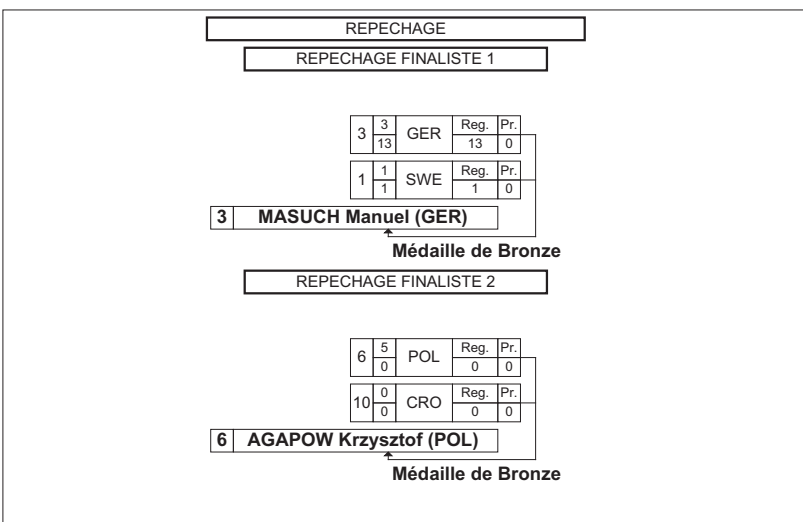



# Feuille de compétition / Competition Sheet

## European Championship - Grappling



STYLE : NoGi-W 53 kg

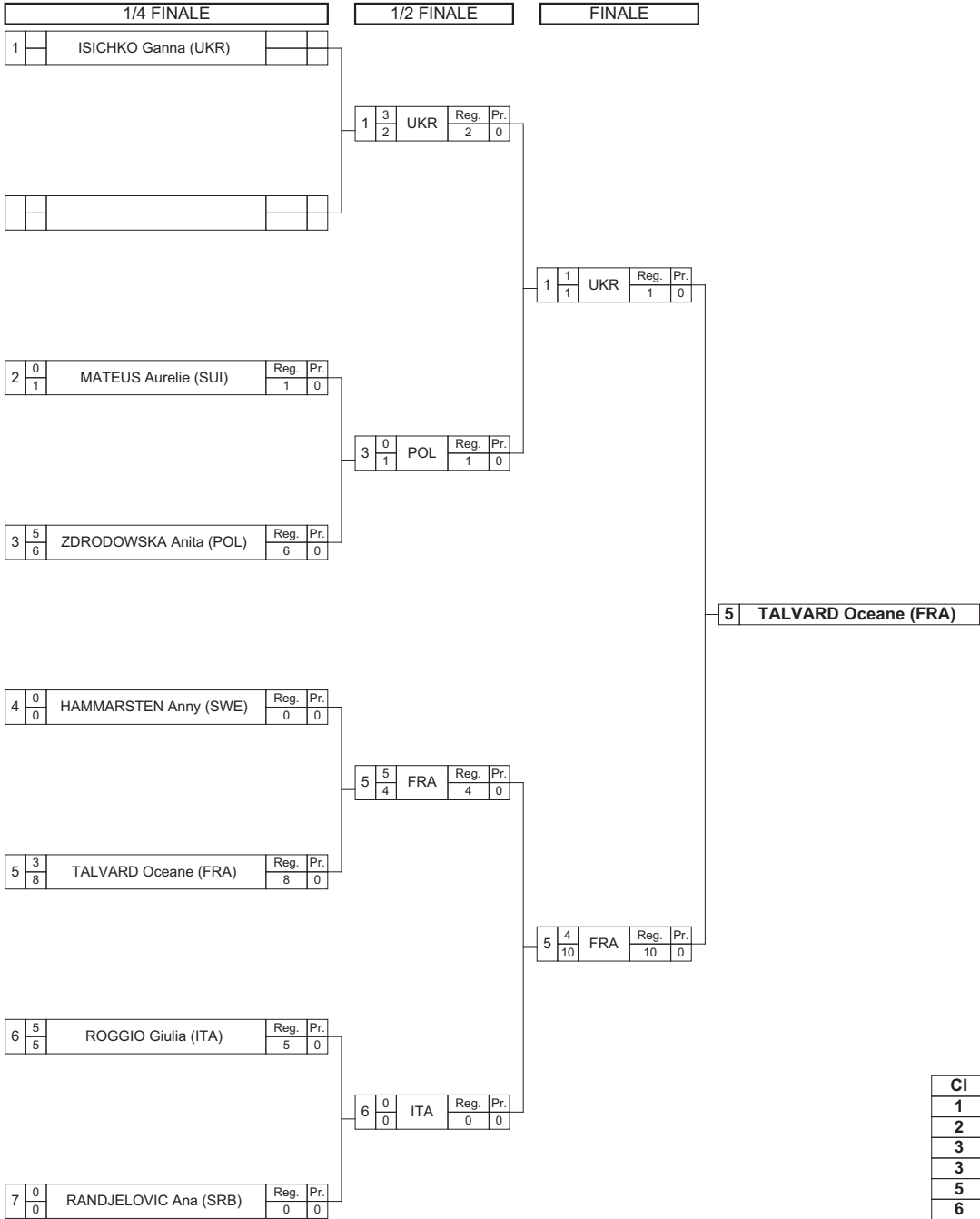

Classement

Cl	Pays	Nom
1	FRA	TALVARD Oceane
2	UKR	ISICHKO Ganna
3	POL	ZDRODOWSKA Anita
3	SWE	HAMMARSTEN Anny
5	ITA	ROGGIO Giulia
6	SUI	MATEUS Aurelie
7	SRB	RANDJELOVIC Ana

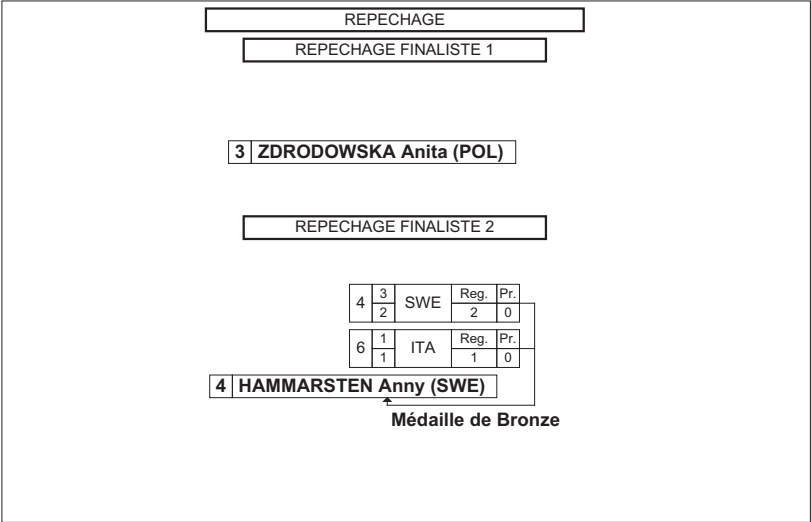



# Feuille de compétition / Competition Sheet

## European Championship - Grappling



STYLE : NoGi-W 58 kg

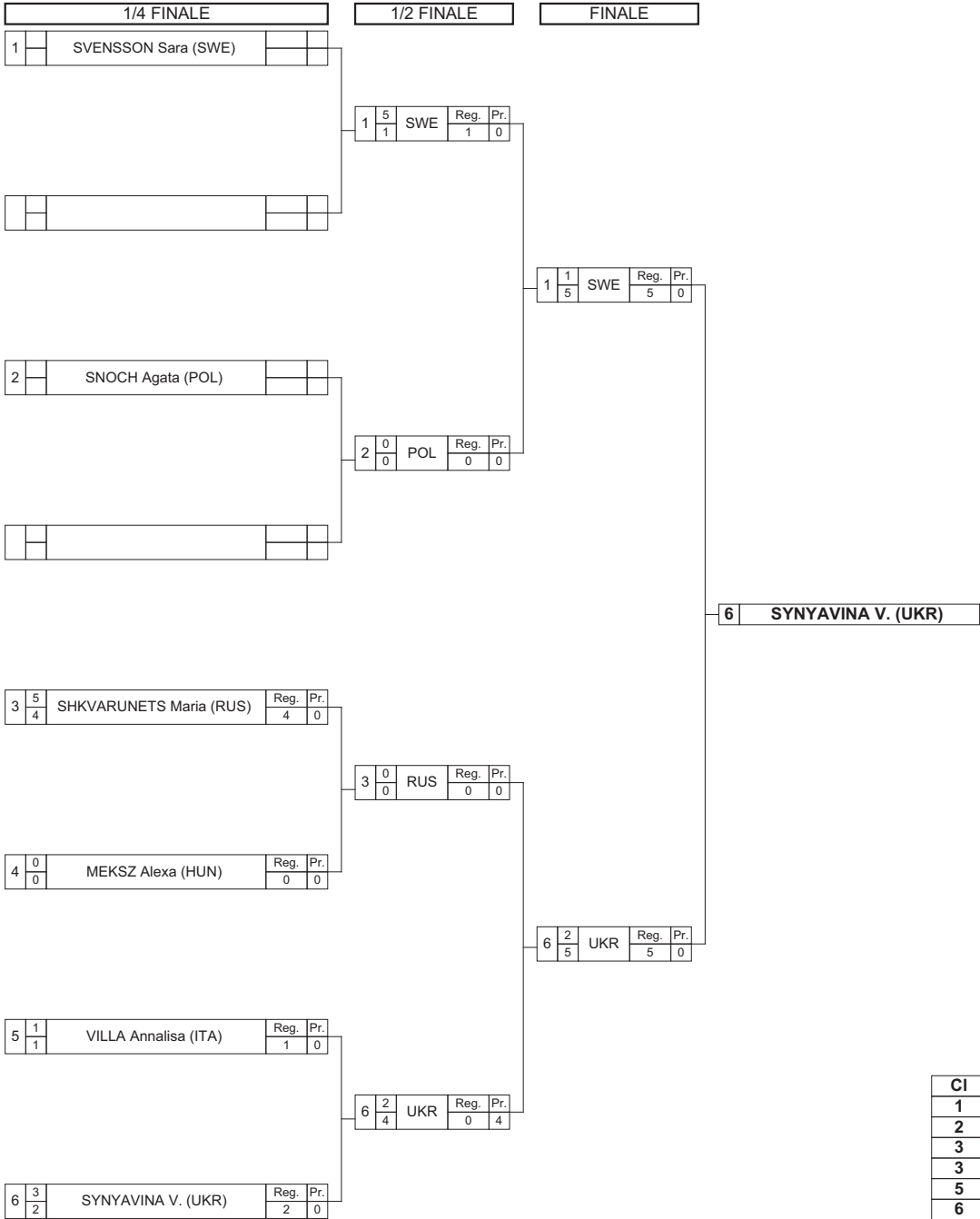

Classement

Cl	Pays	Nom
1	UKR	SYNYAVINA Viktoriia
2	SWE	SVENSSON Sara
3	POL	SNOCH Agata
3	RUS	SHKVARUNETS Maria
5	ITA	VILLA Annalisa
6	HUN	MEKSZ Alexa

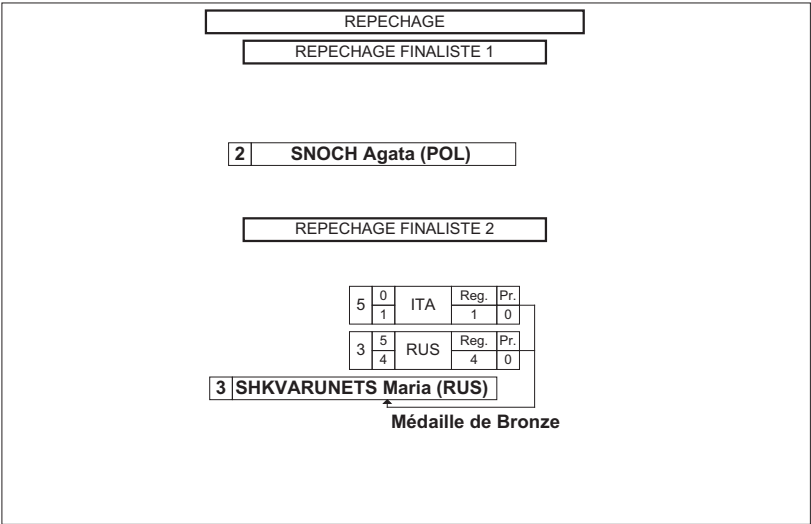





# Feuille de compétition / Competition Sheet

## European Championship - Grappling

STYLE : NoGi-W 71 kg



### TOUR : 1

1	$\frac{5}{8}$	HEDQVIST Sofia (SWE)	Reg	Pr.	1	HEDQVIST Sofia (SWE)
			8	0		
2	$\frac{0}{0}$	TUBA Ana (SRB)	Reg	Pr.		
			0	0		
3	$\frac{1}{2}$	OLEKSIK Monika (POL)	Reg	Pr.	4	PAPADOPOULOU Maria (GRE)
			2	0		
4	$\frac{3}{5}$	PAPADOPOULOU Maria (GRE)	Reg	Pr.		
			5	0		

### TOUR : 2

5	$\frac{0}{0}$	BOCO Laura (ITA)	Reg	Pr.	1	HEDQVIST Sofia (SWE)
			0	0		
1	$\frac{3}{4}$	HEDQVIST Sofia (SWE)	Reg	Pr.		
			4	0		
2	$\frac{3}{3}$	TUBA Ana (SRB)	Reg	Pr.	2	TUBA Ana (SRB)
			3	0		
3	$\frac{0}{0}$	OLEKSIK Monika (POL)	Reg	Pr.		
			0	0		

### TOUR : 3

4	$\frac{1}{1}$	PAPADOPOULOU Maria (GRE)	Reg	Pr.	1	HEDQVIST Sofia (SWE)
			1	0		
1	$\frac{3}{9}$	HEDQVIST Sofia (SWE)	Reg	Pr.		
			9	0		
5	$\frac{5}{0}$	BOCO Laura (ITA)	Reg	Pr.	5	BOCO Laura (ITA)
			0	0		
2	$\frac{0}{0}$	TUBA Ana (SRB)	Reg	Pr.		
			0	0		

### TOUR : 4

3	$\frac{0}{0}$	OLEKSIK Monika (POL)	Reg	Pr.	1	HEDQVIST Sofia (SWE)
			0	0		
1	$\frac{5}{5}$	HEDQVIST Sofia (SWE)	Reg	Pr.		
			5	0		
4	$\frac{3}{1}$	PAPADOPOULOU Maria (GRE)	Reg	Pr.	4	PAPADOPOULOU Maria (GRE)
			1	0		
5	$\frac{0}{0}$	BOCO Laura (ITA)	Reg	Pr.		
			0	0		

### TOUR : 5

2	$\frac{0}{0}$	TUBA Ana (SRB)	Reg	Pr.	4	PAPADOPOULOU Maria (GRE)
			0	0		
4	$\frac{5}{5}$	PAPADOPOULOU Maria (GRE)	Reg	Pr.		
			5	0		
3	$\frac{1}{1}$	OLEKSIK Monika (POL)	Reg	Pr.	5	BOCO Laura (ITA)
			1	0		
5	$\frac{3}{7}$	BOCO Laura (ITA)	Reg	Pr.		
			7	0		

### Classement

Cl	Pays	Nom	Points
1	SWE	HEDQVIST Sofia	16
2	GRE	PAPADOPOULOU Maria	12
3	ITA	BOCO Laura	8
4	SRB	TUBA Ana	3
5	POL	OLEKSIK Monika	2



# Feuille de compétition / Competition Sheet

## European Championship - Grappling

STYLE : NoGi-W p71 kg



### TOUR : 1

1	0	TORIS Suzie (FRA)	Reg	Pr.	2	TIBBLING Klara (SWE)
	1		1	0		
2	5	TIBBLING Klara (SWE)	Reg	Pr.		
	0		0	0		

### TOUR : 2

3	5	MALYJASIAK Maria (POL)	Reg	Pr.	3	MALYJASIAK Maria (POL)
	0		0	0		
1	0	TORIS Suzie (FRA)	Reg	Pr.		
	1		1	0		

### TOUR : 3

2	5	TIBBLING Klara (SWE)	Reg	Pr.	2	TIBBLING Klara (SWE)
	1		1	0		
3	0	MALYJASIAK Maria (POL)	Reg	Pr.		
	2		2	0		

### Classement

Cl	Pays	Nom	Points
1	SWE	TIBBLING Klara	10
2	POL	MALYJASIAK Maria	5
3	FRA	TORIS Suzie	0

